

# OSRAM KW DMLS31.SG

## Datasheet

Not for new design

**Published by ams-OSRAM AG**

Tobelbader Strasse 30, 8141 Premstaetten, Austria

Phone +43 3136 500-0

[ams-osram.com](http://ams-osram.com)

© All rights reserved



## SYNIOS® P2720

# KW DMLS31.SG

This compact LED device is part of the SYNIOS P2720 family. Given the scalability of this product family, it provides full performance and flexibility with just one footprint.

The KW DMLS31.SG product is meant to provide superior light quality in 1 mm<sup>2</sup> chip size class.



## Applications

- Static Signaling

## Features

- Package: SMD epoxy package
- Chip technology: UX:3
- Typ. Radiation: 120° (Lambertian emitter)
- Color: Cx = 0.32, Cy = 0.33 acc. to CIE 1931 (● white)
- Corrosion Robustness Class: 3B
- Qualifications: AEC-Q102 Qualified with RV-level 1
- ESD: 8 kV acc. to ANSI/ESDA/JEDEC JS-001 (HBM, Class 3B)

---

## Ordering Information

| Type                               | Luminous Flux <sup>1)</sup><br>$I_F = 700 \text{ mA}$<br>$\Phi_V$ | Ordering Code |
|------------------------------------|---|---------------|
| KW DMLS31.SG-Z6MF7-ebvFfcbB46-8E8G | 212 ... 334 lm  | Q65112A5690   |

---

## Maximum Ratings

| Parameter  | Symbol    |      | Values  |
|--|-----------|------|---------|
| Operating Temperature  | $T_{op}$  | min. | -40 °C  |
|  |           | max. | 125 °C  |
| Storage Temperature  | $T_{stg}$ | min. | -40 °C  |
|  |           | max. | 125 °C  |
| Junction Temperature   | $T_j$     | max. | 150 °C  |
| Junction Temperature for short time applications*                              | $T_j$     | max. | 175 °C  |
| Forward current<br>$T_s = 25\text{ °C}$  | $I_F$     | min. | 20 mA   |
|  |           | max. | 1000 mA |
| Surge current<br>$t \leq 10\ \mu\text{s}$ ; $D = 0.005$ ; $T_s = 25\text{ °C}$ | $I_{FS}$  | max. | 2500 mA |
| ESD withstand voltage<br>acc. to ANSI/ESDA/JEDEC JS-001 (HBM, Class 3B)        | $V_{ESD}$ |      | 8 kV    |
| Reverse current <sup>2)</sup>  | $I_R$     | max. | 200 mA  |

\* The median lifetime (L70/B50) for  $T_j = 175\text{ °C}$  is 100h.

## Characteristics

$I_F = 700 \text{ mA}$ ;  $T_s = 25 \text{ °C}$

| Parameter  | Symbol                  |      | Values    |
|--|-------------------------|------|-----------|
| Chromaticity Coordinate <sup>3)</sup>  | Cx                      | typ. | 0.32      |
|  | Cy                      | typ. | 0.33      |
| Viewing angle at 50% $I_V$   | $2\phi$                 | typ. | 120 °     |
| Forward Voltage <sup>4)</sup><br>$I_F = 700 \text{ mA}$  | $V_F$                   | min. | 2.75 V    |
|  |                         | typ. | 2.97 V    |
|  |                         | max. | 3.50 V    |
| Reverse voltage (ESD device)   | $V_{R\text{ESD}}$       | min. | 45 V      |
| Reverse voltage <sup>2)</sup><br>$I_R = 20 \text{ mA}$   | $V_R$                   | max. | 1.2 V     |
|  |                         |      |           |
| Real thermal resistance junction/solderpoint <sup>5)</sup>   | $R_{\text{thJS real}}$  | typ. | 7.0 K / W |
|  |                         | max. | 9.0 K / W |
| Electrical thermal resistance junction/solderpoint <sup>5)</sup><br>with efficiency $\eta_e = 30 \%$ | $R_{\text{thJS elec.}}$ | typ. | 4.9 K / W |
|  |                         | max. | 6.3 K / W |

## Brightness Groups

| Group | Luminous Flux <sup>1)</sup><br>$I_F = 700 \text{ mA}$<br>min.<br>$\Phi_V$ | Luminous Flux <sup>1)</sup><br>$I_F = 700 \text{ mA}$<br>max.<br>$\Phi_V$ | Luminous Intensity <sup>6)</sup><br>$I_F = 700 \text{ mA}$<br>typ.<br>$I_v$ |
|-------|---|---|---|
| 6MF   | 212 lm  | 237 lm  | 74 cd   |
| 7M    | 224 lm  | 250 lm  | 78 cd   |
| 7MF   | 237 lm  | 265 lm  | 83 cd   |
| 8M    | 250 lm  | 280 lm  | 88 cd   |
| 8MF   | 265 lm  | 297 lm  | 93 cd   |
| 5N    | 280 lm  | 315 lm  | 98 cd   |
| 5NF   | 297 lm  | 334 lm  | 104 cd  |

## Forward Voltage Groups

| Group | Forward Voltage <sup>4)</sup><br>$I_F = 700 \text{ mA}$<br>min.<br>$V_F$ | Forward Voltage <sup>4)</sup><br>$I_F = 700 \text{ mA}$<br>max.<br>$V_F$ |
|-------|--|--|
| 8E    | 2.75 V   | 3.00 V   |
| 8F    | 3.00 V   | 3.25 V   |
| 8G    | 3.25 V   | 3.50 V   |

### Chromaticity Coordinate Groups

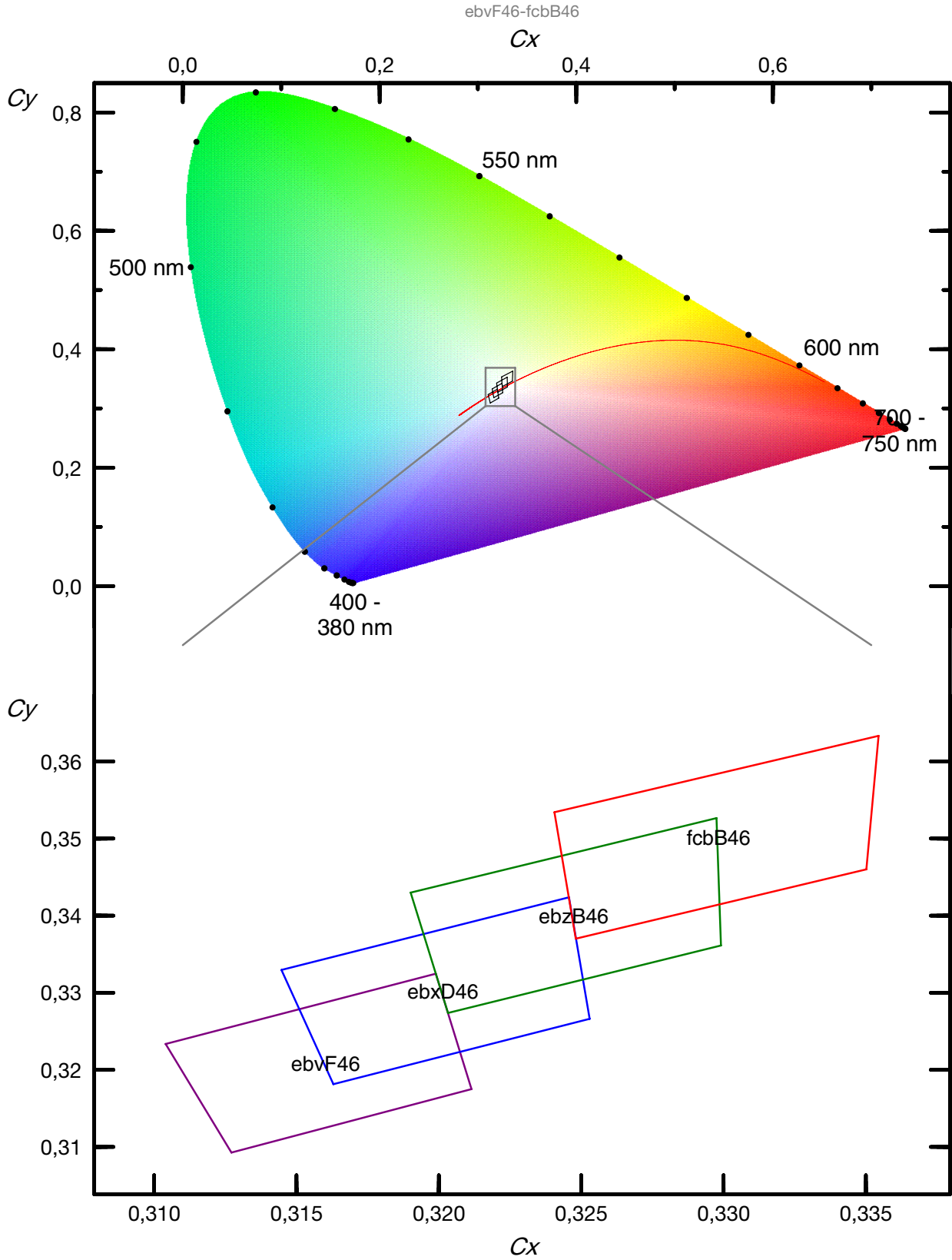

Not for new design

**Chromaticity Coordinate Groups <sup>3)</sup>**

| Group  | Cx     | Cy     | Group  | Cx     | Cy     |
|--------|--------|--------|--------|--------|--------|
| ebvF46 | 0.3104 | 0.3234 | ebzB46 | 0.3190 | 0.3430 |
|        | 0.3199 | 0.3325 |        | 0.3298 | 0.3526 |
|        | 0.3212 | 0.3175 |        | 0.3299 | 0.3361 |
|        | 0.3127 | 0.3093 |        | 0.3203 | 0.3274 |
| ebxD46 | 0.3145 | 0.3330 | fcbB46 | 0.3241 | 0.3534 |
|        | 0.3246 | 0.3424 |        | 0.3355 | 0.3633 |
|        | 0.3253 | 0.3266 |        | 0.3350 | 0.3460 |
|        | 0.3163 | 0.3181 |        | 0.3248 | 0.3370 |



---

## Group Name on Label

**Example: 5N-ebvF46-8E**

| Brightness | Color Chromaticity | Forward Voltage |
|------------|--------------------|-----------------|
| 5N         | ebvF46             | 8E              |

---

### Relative Spectral Emission <sup>6)</sup>

$\Phi_{rel} = f(\lambda); I_F = 700 \text{ mA}; T_S = 25 \text{ }^\circ\text{C}$

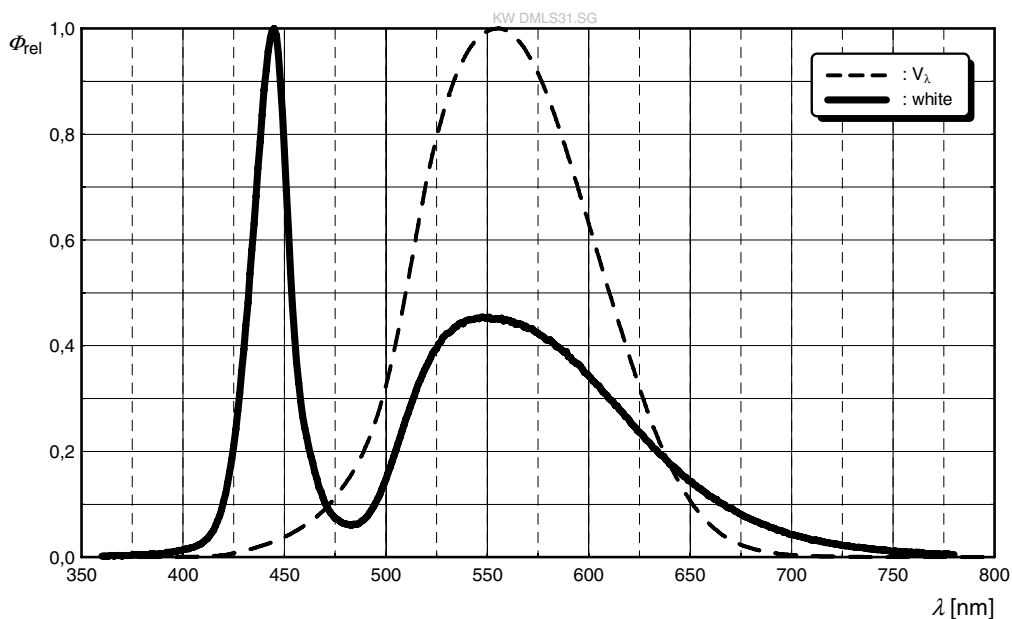

### Radiation Characteristics <sup>6)</sup>

$I_{rel} = f(\phi); T_S = 25 \text{ }^\circ\text{C}$

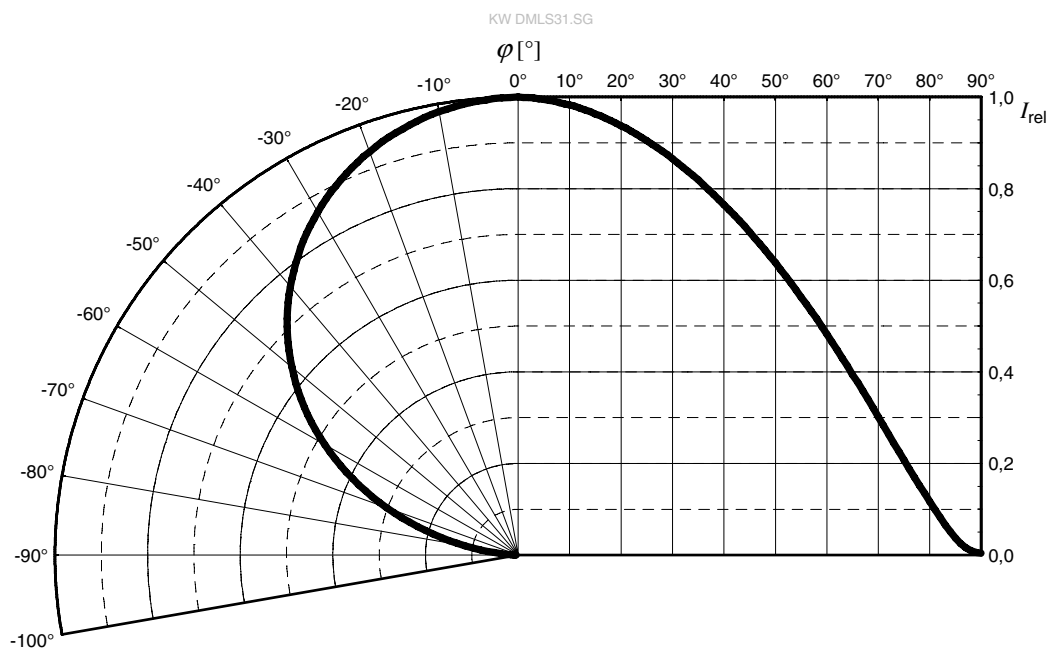

Not for new design

**Forward current** 6), 7)

$I_F = f(V_F); T_S = 25\text{ °C}$

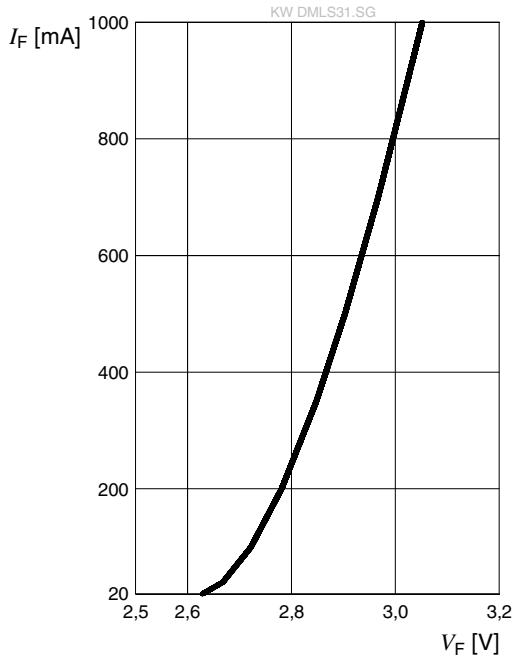

**Relative Luminous Flux** 6), 7)

$\Phi_V / \Phi_V(700\text{ mA}) = f(I_F); T_S = 25\text{ °C}$

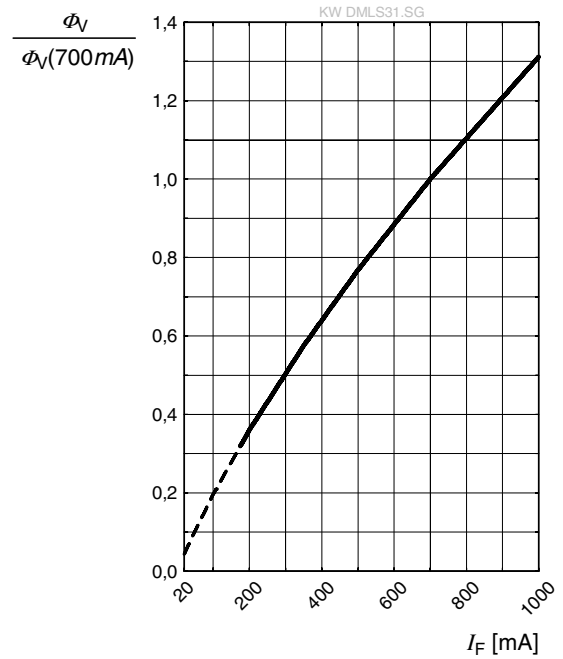

**Chromaticity Coordinate Shift** 6)

$\Delta C_x, \Delta C_y = f(I_F); T_S = 25\text{ °C}$

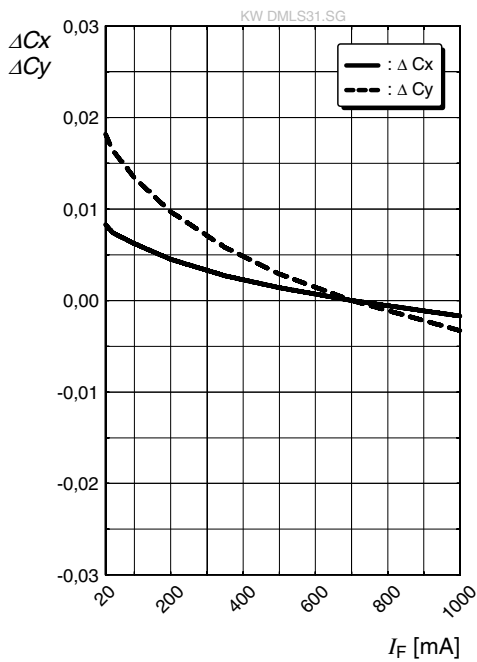

Not for new design

### Forward Voltage <sup>6)</sup>

$$\Delta V_F = V_F - V_F(25^\circ\text{C}) = f(T_j); I_F = 700\text{ mA}$$

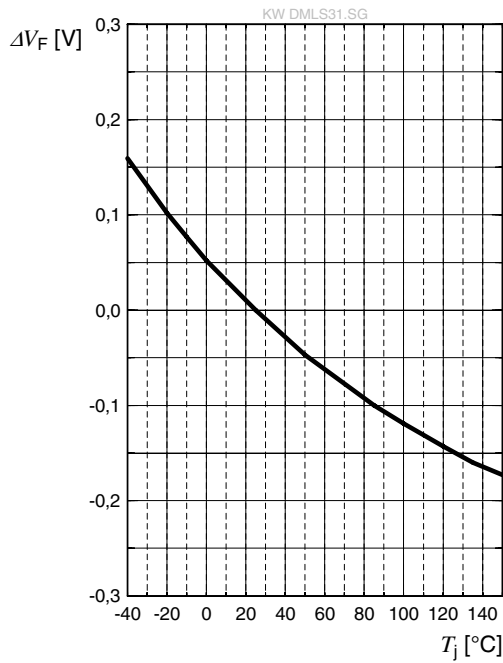

### Relative Luminous Flux <sup>6)</sup>

$$\Phi_V / \Phi_V(25^\circ\text{C}) = f(T_j); I_F = 700\text{ mA}$$

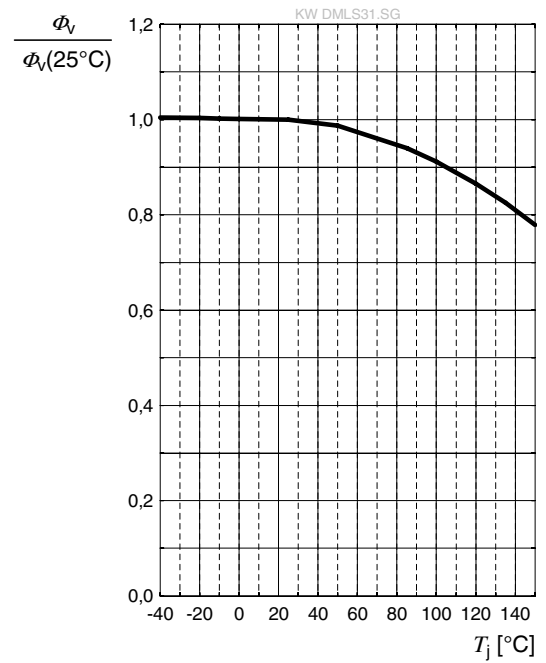

### Chromaticity Coordinate Shift <sup>6)</sup>

$$\Delta C_x, \Delta C_y = f(T_j); I_F = 700\text{ mA}$$

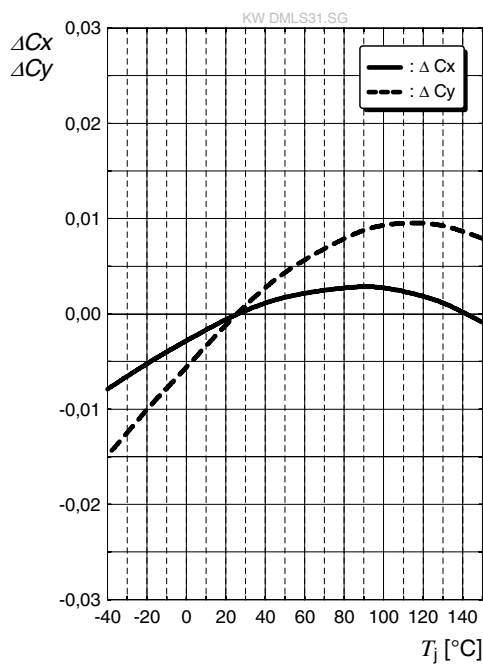

Not for new design

### Max. Permissible Forward Current

$I_F = f(T)$

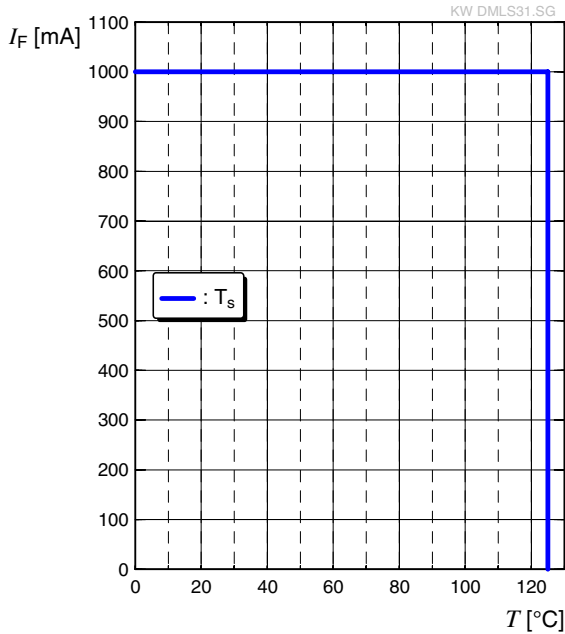

### Permissible Pulse Handling Capability

$I_F = f(t_p)$ ; D: Duty cycle

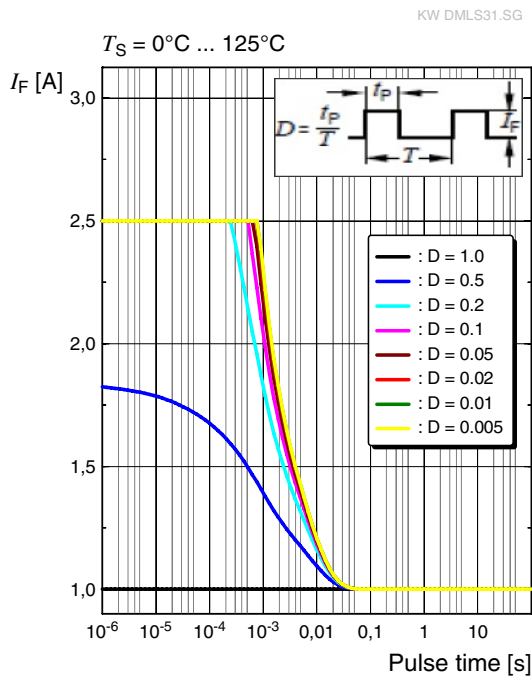

### Permissible Pulse Handling Capability

$I_F = f(t_p)$ ; D: Duty cycle

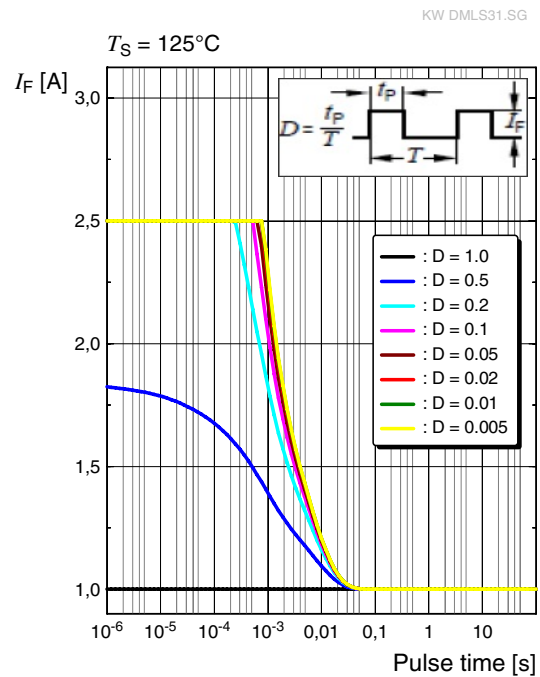

Not for new design

**Dimensional Drawing** <sup>8)</sup>

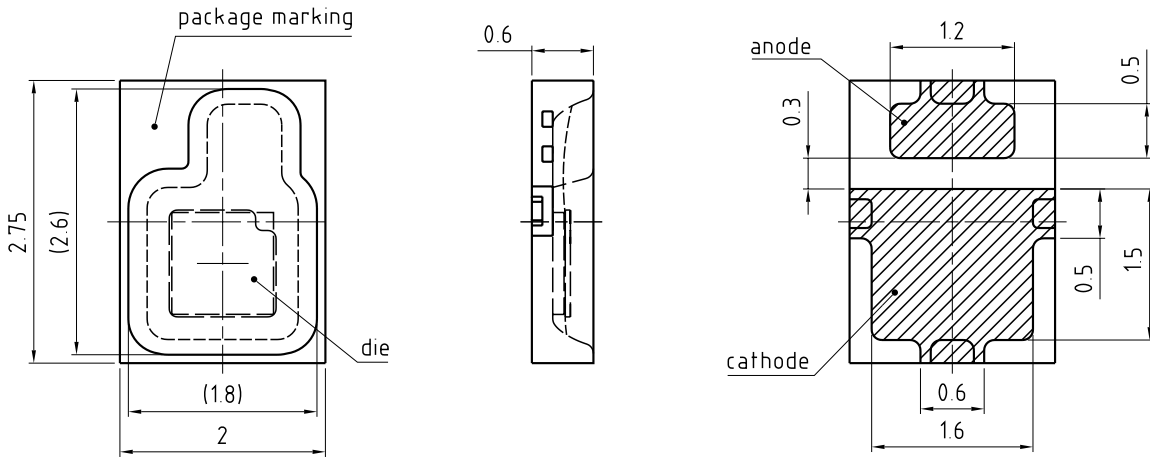

General tolerance ±0.1

Lead finish Au 

C67062-A0116-A11-04

**Further Information:**

**Approximate Weight:** 12.0 mg

**Corrosion test:** Class: 3B  
Test condition: 40°C / 90 % RH / 15 ppm H<sub>2</sub>S / 14 days (stricter than IEC 60068-2-43)

**ESD advice:** The device is protected by ESD device which is connected in parallel to the Chip.

Electrical Internal Circuit

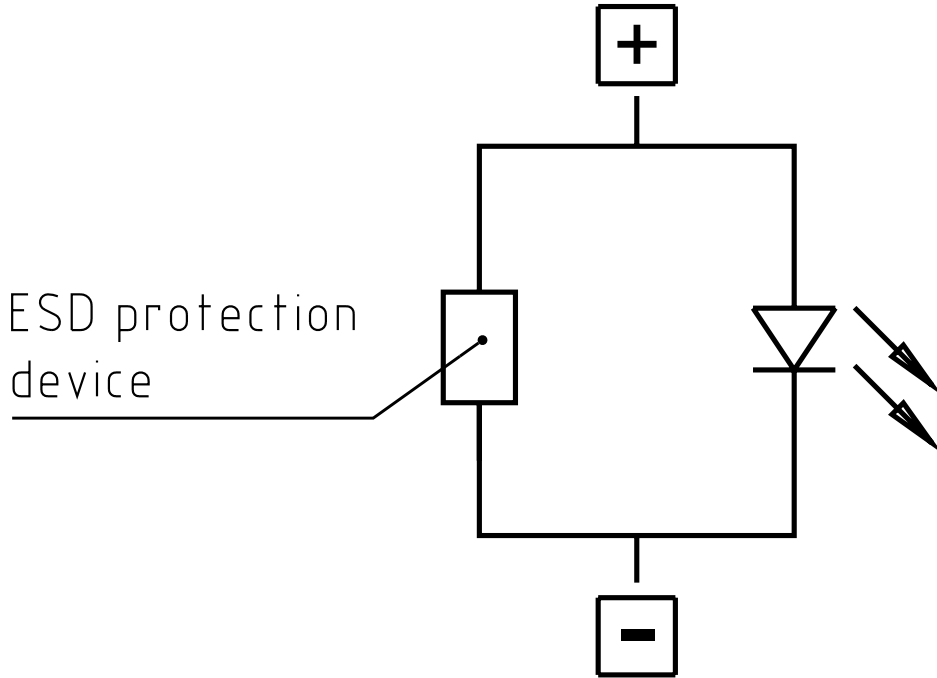

Recommended Solder Pad <sup>8)</sup>

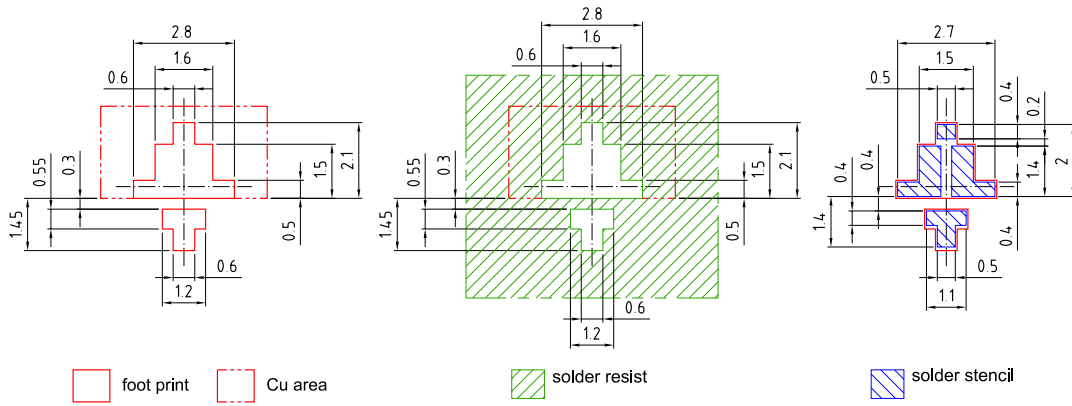

Component Location on Pad

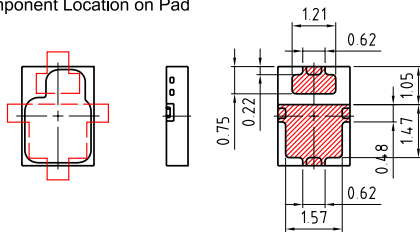

E062.3010.181 -02

Not for new design

For superior solder joint connectivity results we recommend soldering under standard nitrogen atmosphere. Package not suitable for ultra sonic cleaning.

## Reflow Soldering Profile

Product complies to MSL Level 2 acc. to JEDEC J-STD-020E

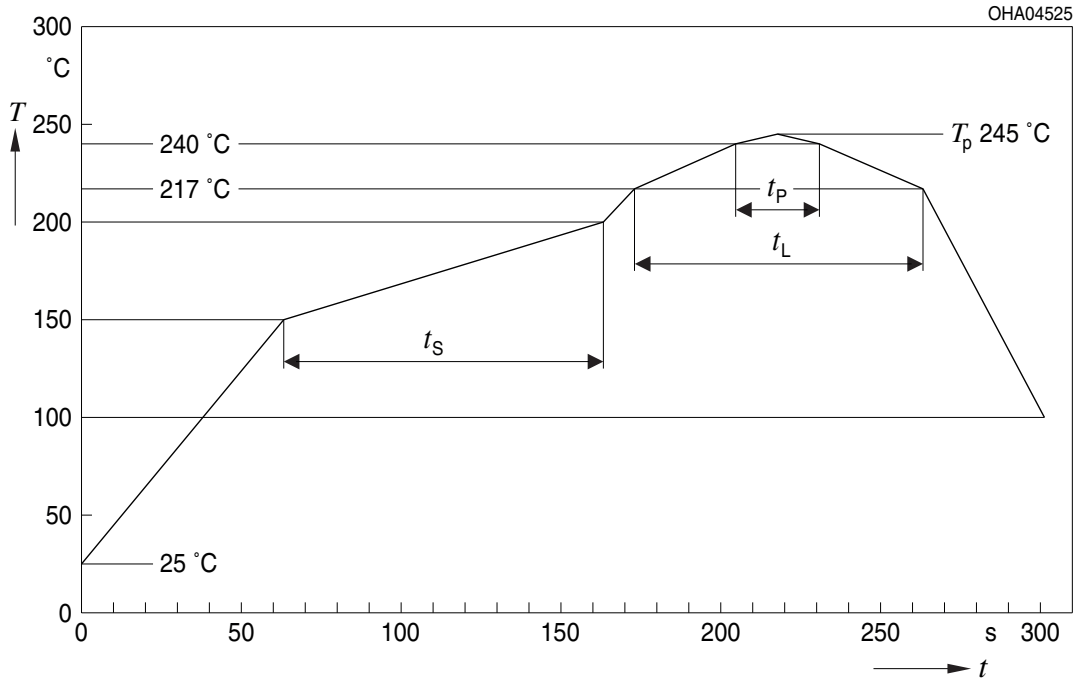

| Profile Feature   | Symbol | Pb-Free (SnAgCu) Assembly |                |         | Unit |
|---|--------|---------------------------|----------------|---------|------|
|   |        | Minimum                   | Recommendation | Maximum |      |
| Ramp-up rate to preheat <sup>*)</sup><br>25 °C to 150 °C          |        |                           | 2              | 3       | K/s  |
| Time $t_s$<br>$T_{Smin}$ to $T_{Smax}$                            | $t_s$  | 60                        | 100            | 120     | s    |
| Ramp-up rate to peak <sup>*)</sup><br>$T_{Smax}$ to $T_p$         |        |                           | 2              | 3       | K/s  |
| Liquidus temperature  | $T_L$  |                           | 217            |         | °C   |
| Time above liquidus temperature                                   | $t_L$  |                           | 80             | 100     | s    |
| Peak temperature  | $T_p$  |                           | 245            | 260     | °C   |
| Time within 5 °C of the specified peak<br>temperature $T_p - 5$ K | $t_p$  | 10                        | 20             | 30      | s    |
| Ramp-down rate*<br>$T_p$ to 100 °C                                |        |                           | 3              | 6       | K/s  |
| Time<br>25 °C to $T_p$  |        |                           |                | 480     | s    |

All temperatures refer to the center of the package, measured on the top of the component  
\* slope calculation  $DT/Dt$ :  $Dt$  max. 5 s; fulfillment for the whole T-range

Not for new design



Taping <sup>8)</sup>

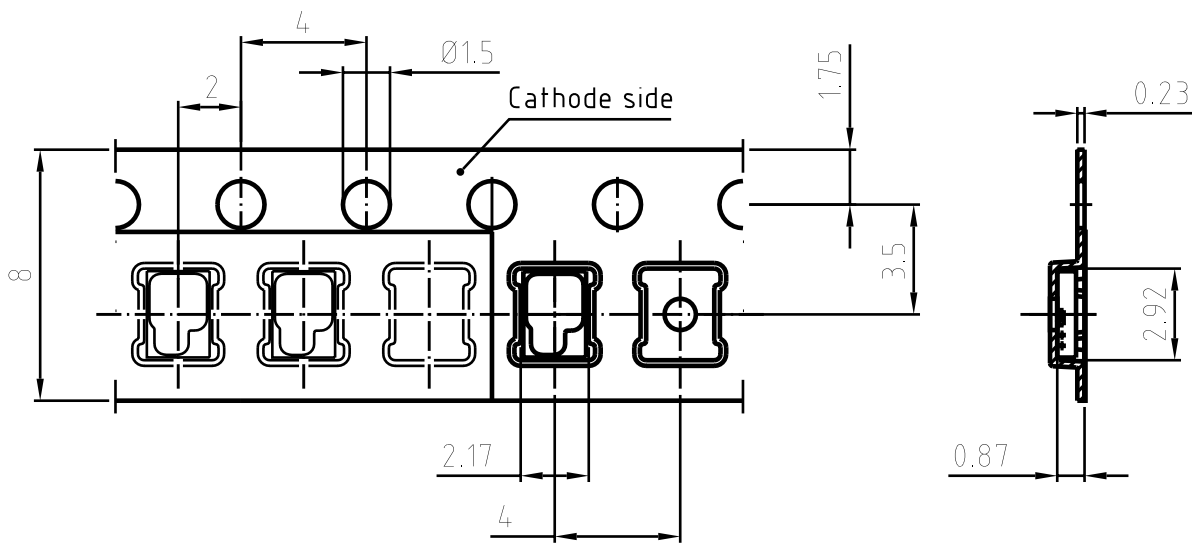

C67062-A0116-B9-04

**Tape and Reel** <sup>9)</sup>

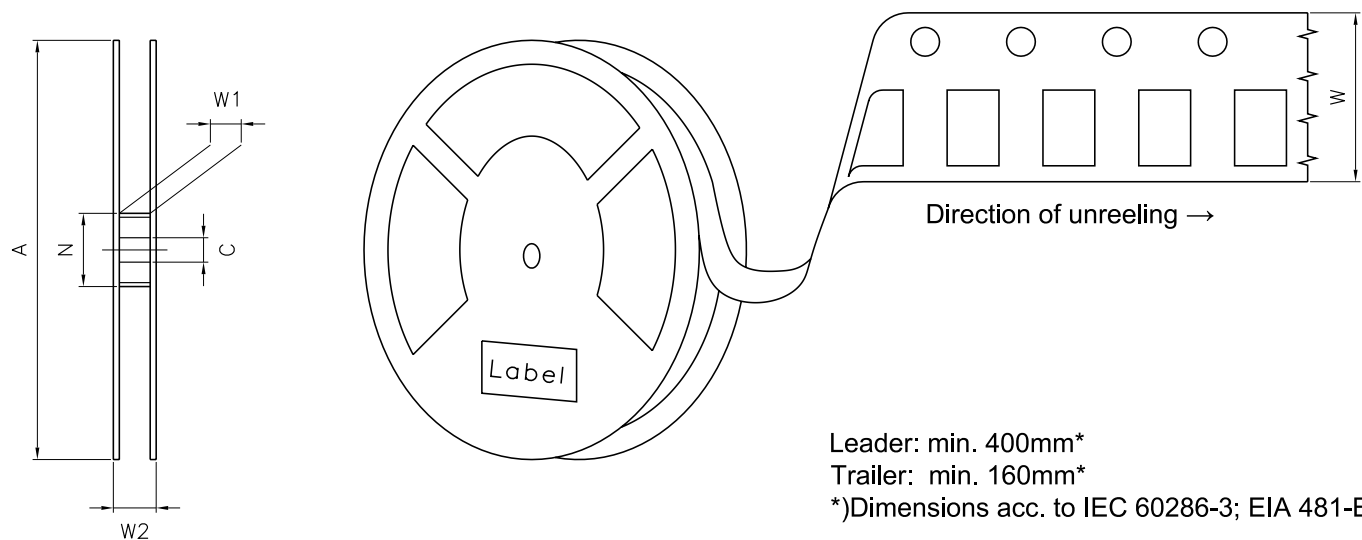

**Reel Dimensions**

| A      | W                  | N <sub>min</sub> | W <sub>1</sub> | W <sub>2 max</sub> | Pieces per PU |
|--------|--------------------|------------------|----------------|--------------------|---------------|
| 180 mm | 8 + 0.3 / - 0.1 mm | 60 mm            | 8.4 + 2 mm     | 14.4 mm            | 4000          |

### Barcode-Product-Label (BPL)

**OSRAM** LX XXXX BIN1: XX-XX-X-XXX-X

RoHS Compliant

(6P) BATCH NO: 1234567890

(1T) LOT NO: 1234567890 (9D) D/C: 1234

(X) PROD NO: 123456789 (Q) QTY: 9999 (G) GROUP: XX-XX-X-X

ML Temp ST  
X XXX °C X

Pack: RXX  
DEMY XXX  
X\_X123\_1234.1234 X

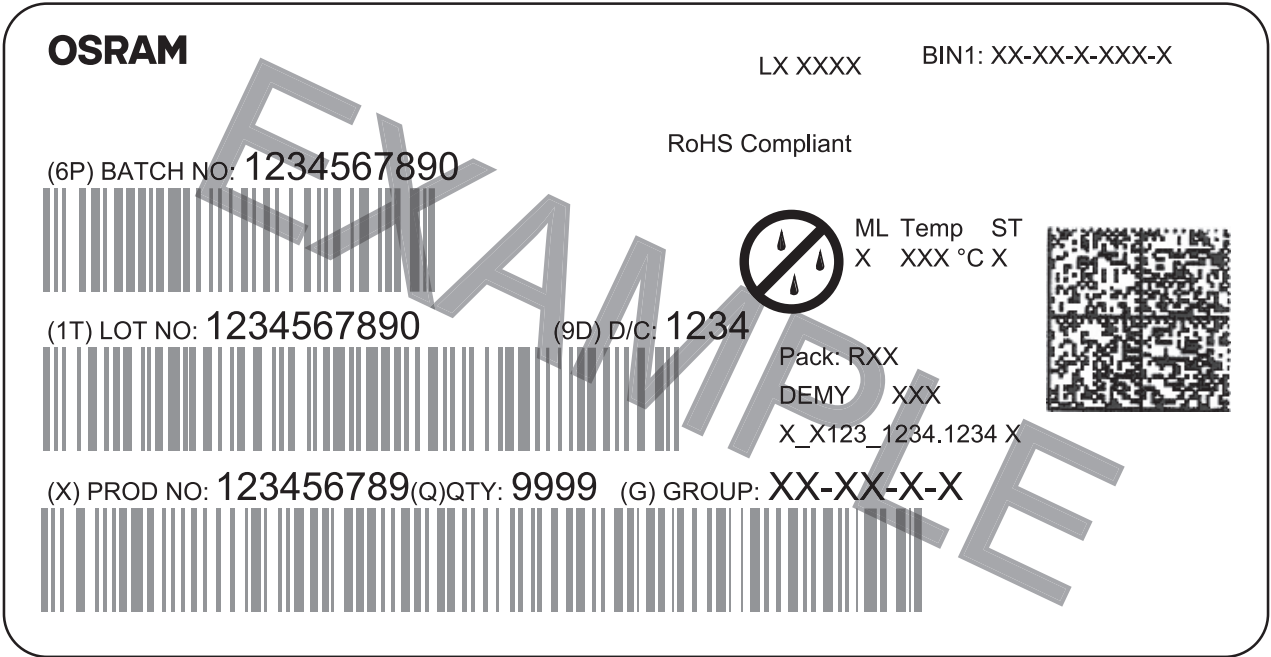

The diagram shows a rounded rectangular label with the OSRAM logo at the top left. To its right are the fields 'LX XXXX' and 'BIN1: XX-XX-X-XXX-X'. Below the logo is the text 'RoHS Compliant'. The label features three horizontal barcode sections. The first is labeled '(6P) BATCH NO: 1234567890'. The second is labeled '(1T) LOT NO: 1234567890' and '(9D) D/C: 1234'. The third is labeled '(X) PROD NO: 123456789 (Q) QTY: 9999 (G) GROUP: XX-XX-X-X'. To the right of the second barcode is a 'No Moisture' symbol (a circle with a diagonal line and three drops) and the text 'ML Temp ST X XXX °C X'. Below that is 'Pack: RXX', 'DEMY XXX', and 'X\_X123\_1234.1234 X'. A square QR code is located on the right side of the label.

OHA04563

### Dry Packing Process and Materials <sup>8)</sup>

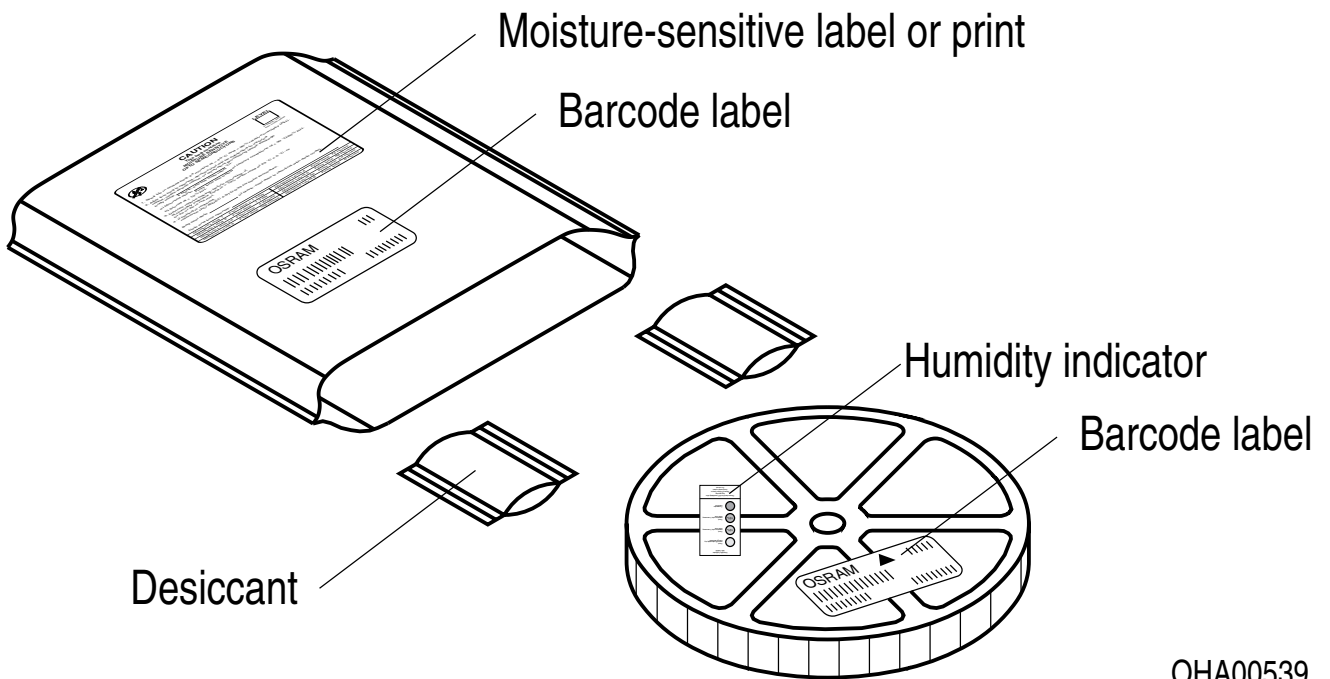

OHA00539

Moisture-sensitive product is packed in a dry bag containing desiccant and a humidity card according JEDEC-STD-033.

Not for new design

---

## Notes

The evaluation of eye safety occurs according to the standard IEC 62471:2006 (photo biological safety of lamps and lamp systems). Within the risk grouping system of this IEC standard, the device specified in this data sheet fall into the class **moderate risk (exposure time 0.25 s)**. Under real circumstances (for exposure time, conditions of the eye pupils, observation distance), it is assumed that no endangerment to the eye exists from these devices. As a matter of principle, however, it should be mentioned that intense light sources have a high secondary exposure potential due to their blinding effect. When looking at bright light sources (e.g. headlights), temporary reduction in visual acuity and afterimages can occur, leading to irritation, annoyance, visual impairment, and even accidents, depending on the situation.

Subcomponents of this device contain, in addition to other substances, metal filled materials including silver. Metal filled materials can be affected by environments that contain traces of aggressive substances. Therefore, we recommend that customers minimize device exposure to aggressive substances during storage, production, and use. Devices that showed visible discoloration when tested using the described tests above did show no performance deviations within failure limits during the stated test duration. Respective failure limits are described in the IEC60810.

For further application related information please visit [www.osram-os.com/appnotes](http://www.osram-os.com/appnotes)

---

## Disclaimer

### Attention please!

The information describes the type of component and shall not be considered as assured characteristics. Terms of delivery and rights to change design reserved. Due to technical requirements components may contain dangerous substances.

For information on the types in question please contact our Sales Organization.

If printed or downloaded, please find the latest version on our website.

### Packing

Please use the recycling operators known to you. We can also help you – get in touch with your nearest sales office. By agreement we will take packing material back, if it is sorted. You must bear the costs of transport. For packing material that is returned to us unsorted or which we are not obliged to accept, we shall have to invoice you for any costs incurred.

### Product and functional safety devices/applications or medical devices/applications

Our components are not developed, constructed or tested for the application as safety relevant component or for the application in medical devices.

Our products are not qualified at module and system level for such application.

In case buyer – or customer supplied by buyer – considers using our components in product safety devices/ applications or medical devices/applications, buyer and/or customer has to inform our local sales partner immediately and we and buyer and /or customer will analyze and coordinate the customer-specific request between us and buyer and/or customer.

## Glossary

- 1) **Brightness:** Brightness values are measured during a current pulse of typically 25 ms, with an internal reproducibility of  $\pm 8\%$  and an expanded uncertainty of  $\pm 11\%$  (acc. to GUM with a coverage factor of  $k = 3$ ).
- 2) **Reverse Operation:** This product is intended to be operated applying a forward current within the specified range. Applying any continuous reverse bias or forward bias below the voltage range of light emission shall be avoided because it may cause migration which can change the electro-optical characteristics or damage the LED.
- 3) **Chromaticity coordinate groups:** Chromaticity coordinates are measured during a current pulse of typically 25 ms, with an internal reproducibility of  $\pm 0.005$  and an expanded uncertainty of  $\pm 0.01$  (acc. to GUM with a coverage factor of  $k = 3$ ).
- 4) **Forward Voltage:** The forward voltage is measured during a current pulse of typically 8 ms, with an internal reproducibility of  $\pm 0.05$  V and an expanded uncertainty of  $\pm 0.1$  V (acc. to GUM with a coverage factor of  $k = 3$ ).
- 5) **Thermal Resistance:**  $R_{th\ max}$  is based on statistic values ( $6\sigma$ ).
- 6) **Typical Values:** Due to the special conditions of the manufacturing processes of semiconductor devices, the typical data or calculated correlations of technical parameters can only reflect statistical figures. These do not necessarily correspond to the actual parameters of each single product, which could differ from the typical data and calculated correlations or the typical characteristic line. If requested, e.g. because of technical improvements, these typ. data will be changed without any further notice.
- 7) **Characteristic curve:** In the range where the line of the graph is broken, you must expect higher differences between single devices within one packing unit.
- 8) **Tolerance of Measure:** Unless otherwise noted in drawing, tolerances are specified with  $\pm 0.1$  and dimensions are specified in mm.
- 9) **Tape and Reel:** All dimensions and tolerances are specified acc. IEC 60286-3 and specified in mm.

---

## Revision History

| Version | Date       | Change   |
|---------|------------|--|
| 1.6     | 2019-09-03 | Not for new design   |
| 1.7     | 2021-02-18 | Features<br>Schematic Transportation Box<br>Dimensions of Transportation Box<br>Glossary |
| 1.8     | 2023-03-07 | New Layout<br>Reel Dimensions  |

---

Not for new design

---



EU RoHS and China RoHS compliant product

此产品符合欧盟 RoHS 指令的要求；  
按照中国的相关法规和标准，  
不含有毒有害物质或元素。

**Published by ams-OSRAM AG**

Tobelbader Strasse 30, 8141 Premstaetten, Austria

Phone +43 3136 500-0

[ams-osram.com](http://ams-osram.com)

© All rights reserved

**am** 

**OSRAM**